







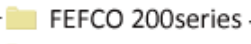
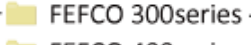
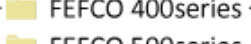
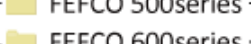
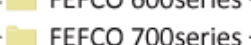
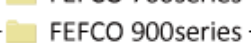

ACDS.1

# ArtiosCAD Designer Solution

ArtiosCAD containers&Trays

 Corrugated			
 1,Artops CAD Corrugated	-----	資料NO. ACDS.1	ファイル名 Artops CAD Corrugated & Trays
 2,FEFCO			
 FEFCO 200series	-----	ACDS.2	FEFCO 200series
 FEFCO 300series	-----	ACDS.3	FEFCO 300series
 FEFCO 400series	-----	ACDS.4	FEFCO 400series
 FEFCO 500series	-----	ACDS.5	FEFCO 500,600series
 FEFCO 600series	-----	ACDS.6	FEFCO 700,900series
 FEFCO 700series	-----		
 FEFCO 900series	-----		
 2b,FEFCO(nur metrisch)	-----	ACDS.7	FEFCO nur metrisch200,400,700serie
 Folding Carton			
 1,ArtiosCAD Folding Carton	---	資料NO. ACDS.8	ファイル名 ArtiosCAD foldingCarton
 2,ECMA	-----	ACDS.9	foldingCarton2,ECMA



Printer

**UJF-6042**

UV PRINTER



Cutting plotter

**CFL-605RT**



 Ink

LH-100

 Media

Coated card board 230g

 Laminating film

PP Hot Laminating film  
9327KA × 500 25μ



# 1 side rolover

ACDS.1-1

Mimaki™

File name

## Cover flaps

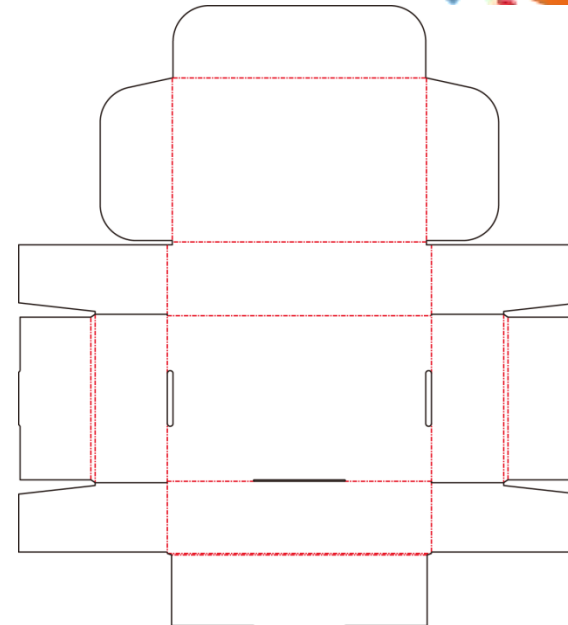
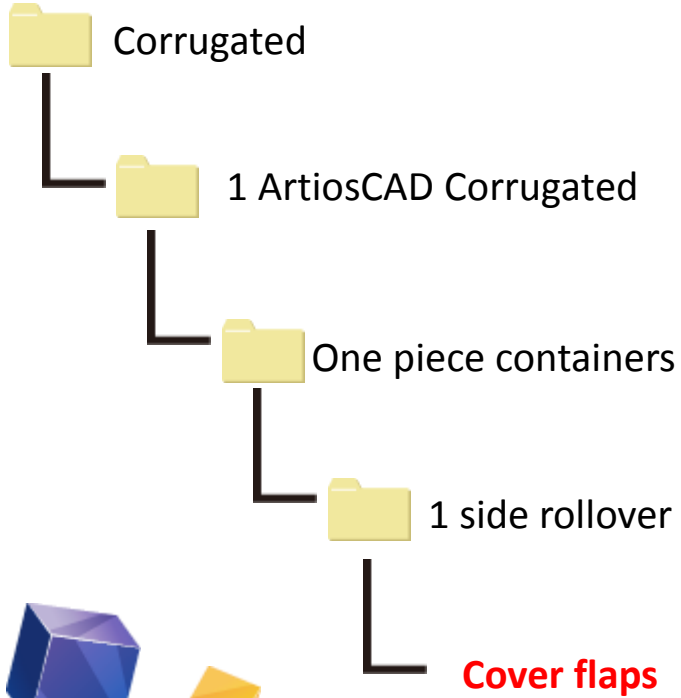

# 1 side rollover

ACDS.1-2

File name

## Cover flaps & lock

Corrugated

1 ArtiosCAD Corrugated

One piece containers

1 side rollover

Cover flaps & lock

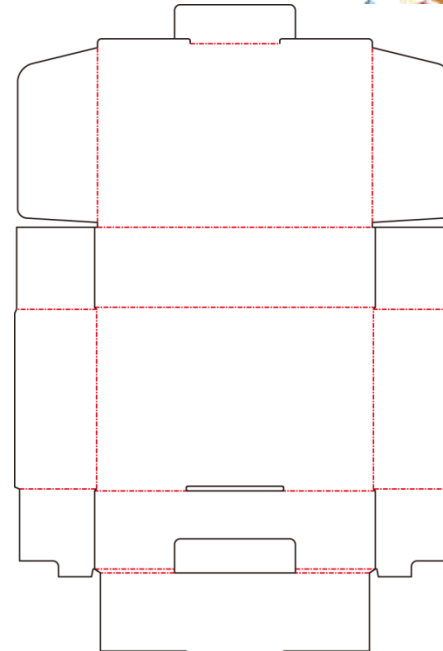

MIMAKI

# 1 side rolover

ACDS.1-3

File name

## Ears

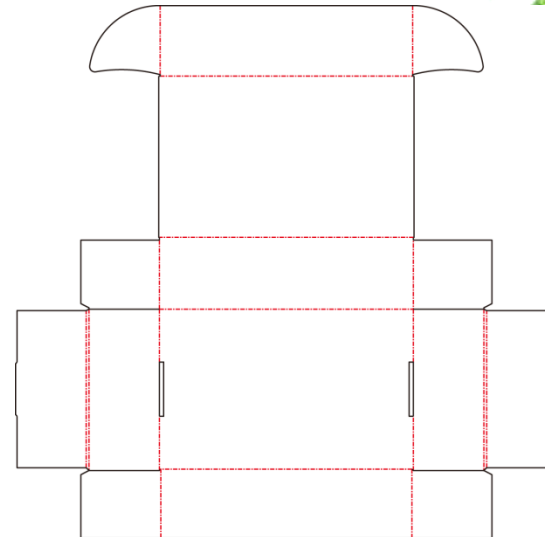
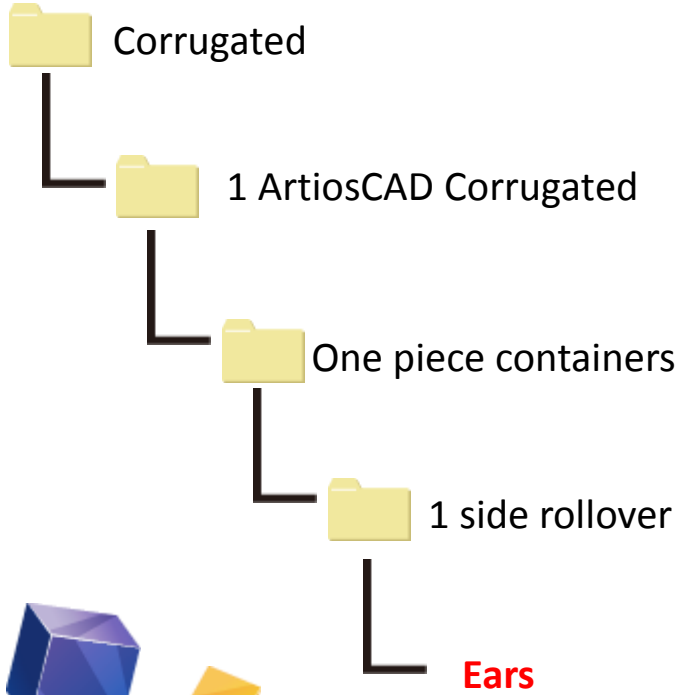

Mimaki™

# 1 side rollover

ACDS.1-4

MIMAKI™

File name

Ears/dust flaps off  
cover

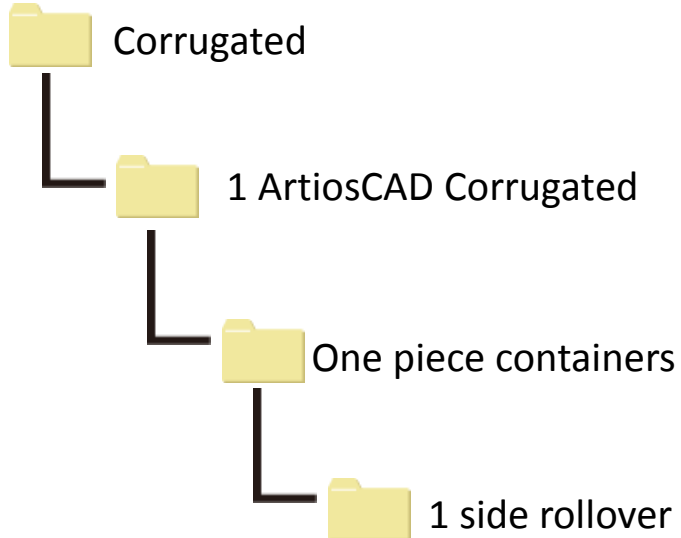

**Ears/dust flaps off cover**

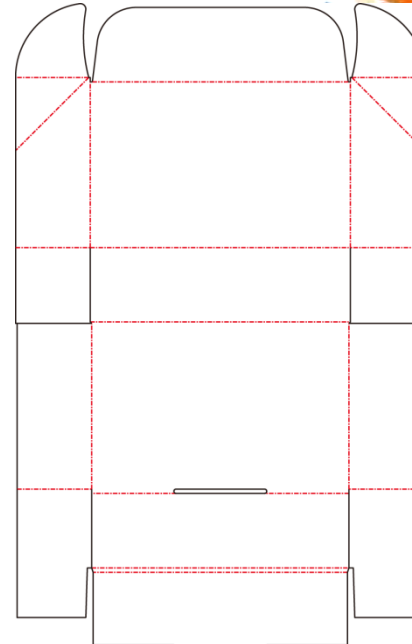

# 2 side rolover

ACDS.1-5

Mimaki™

File name

## Cover flaps

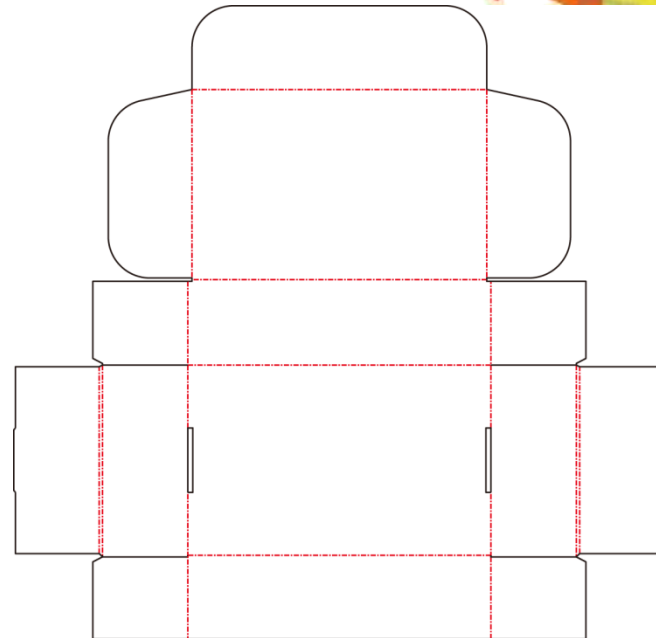
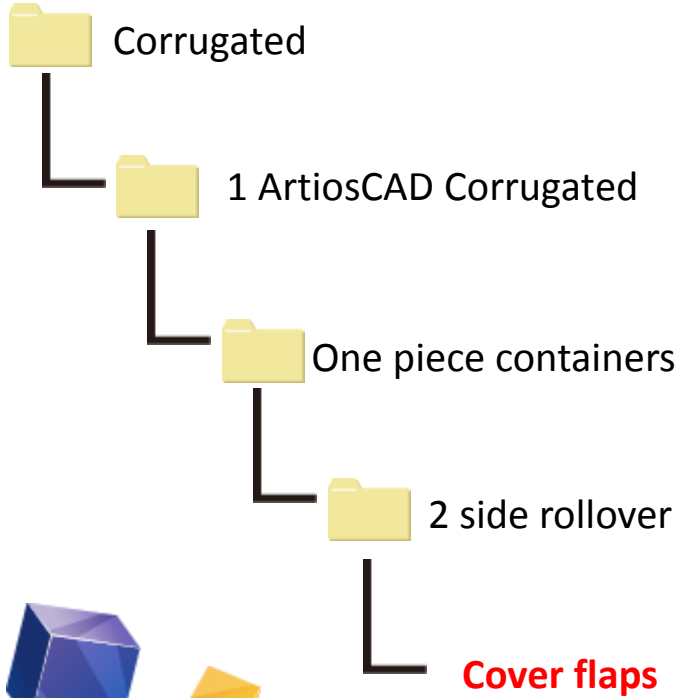

# 2 side rolover

ACDS.1-6

File name  
**Cover flaps & ears**

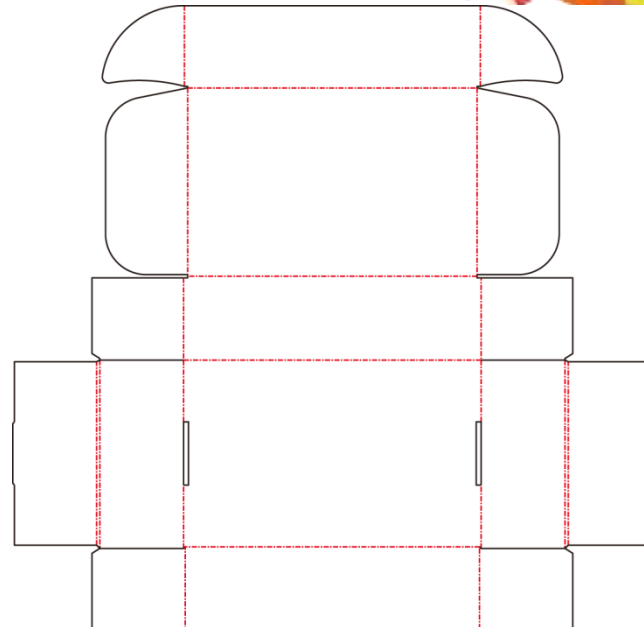
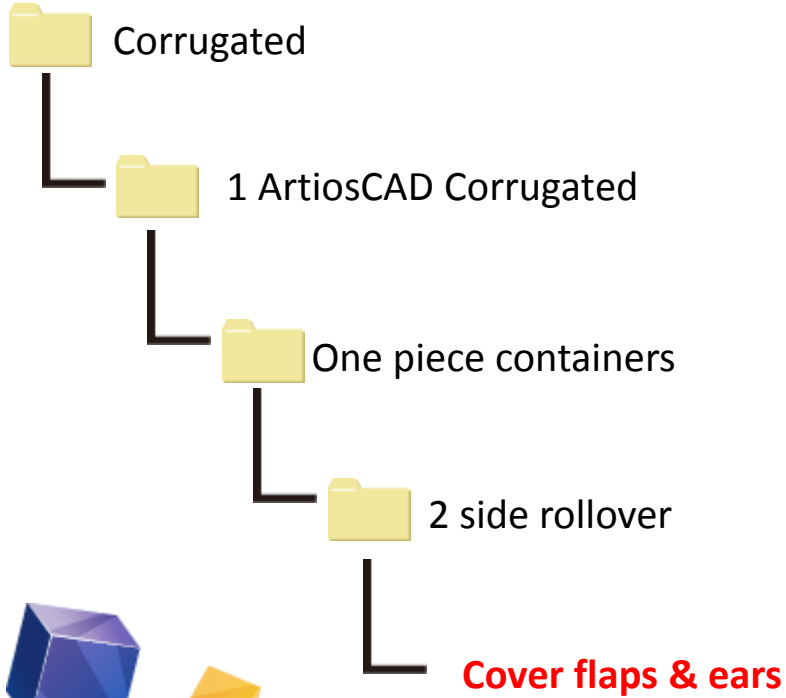



# 2 side rolover

ACDS.1-7

Mimaki™

File name

## Cover panels meet

Corrugated

1 ArtiosCAD Corrugated

One piece containers

2 side rolover

Cover panels meet

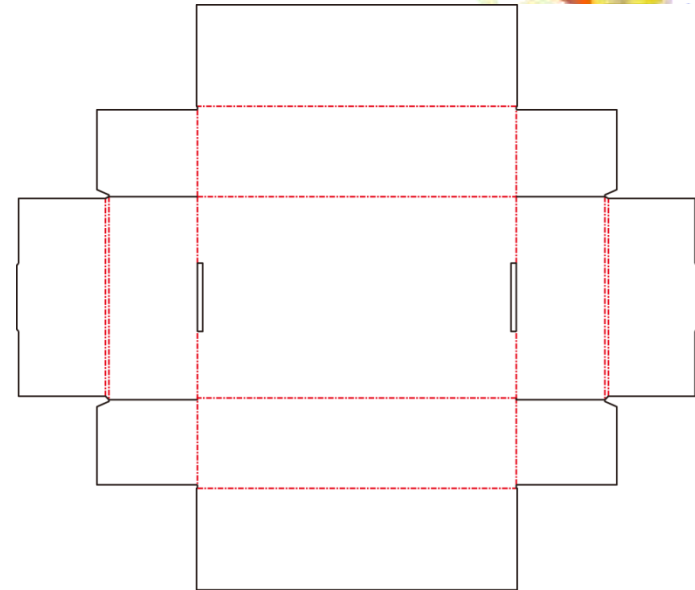

# 2 side rollover

ACDS.1-8

File name

**Ears**

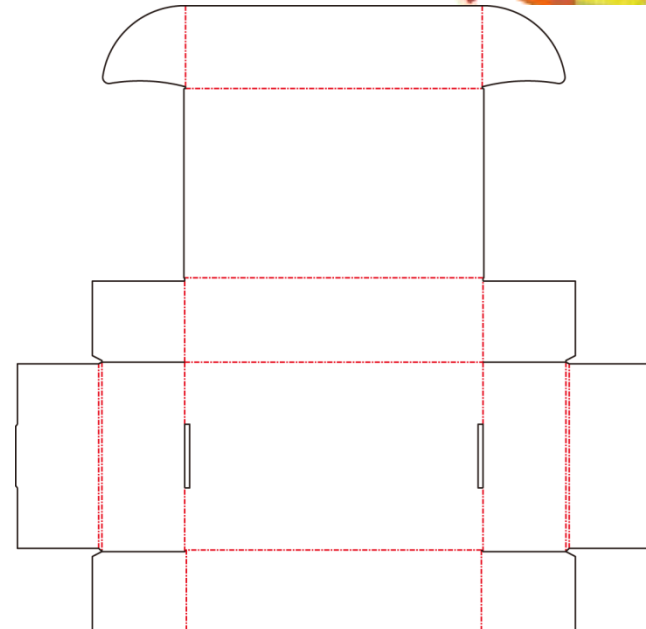
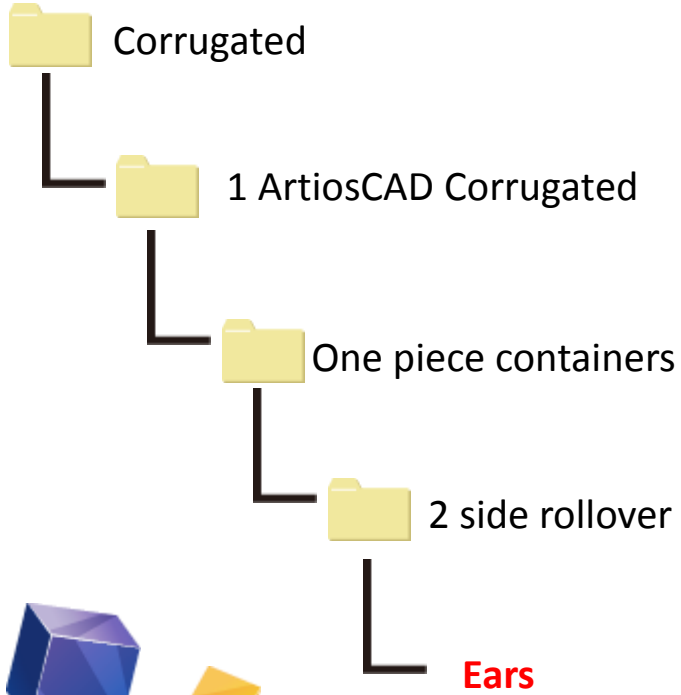

# 2 side rollover

ACDS.1-9

MIMAKI™

File name

# Tuck

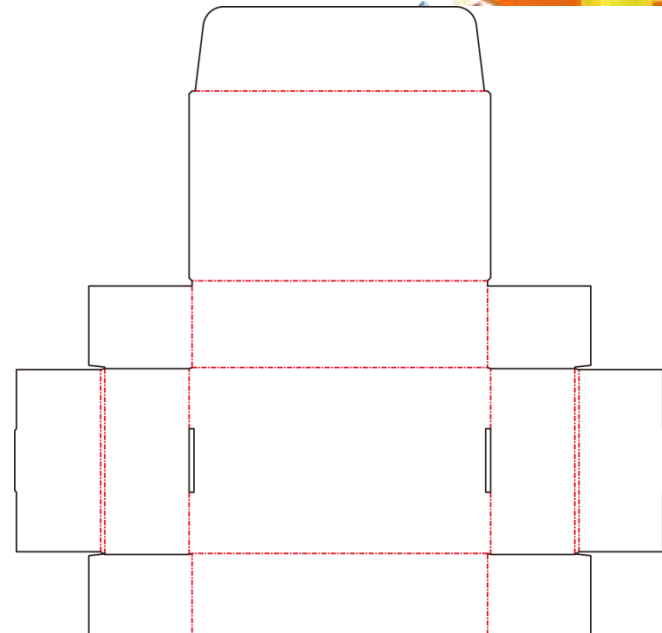
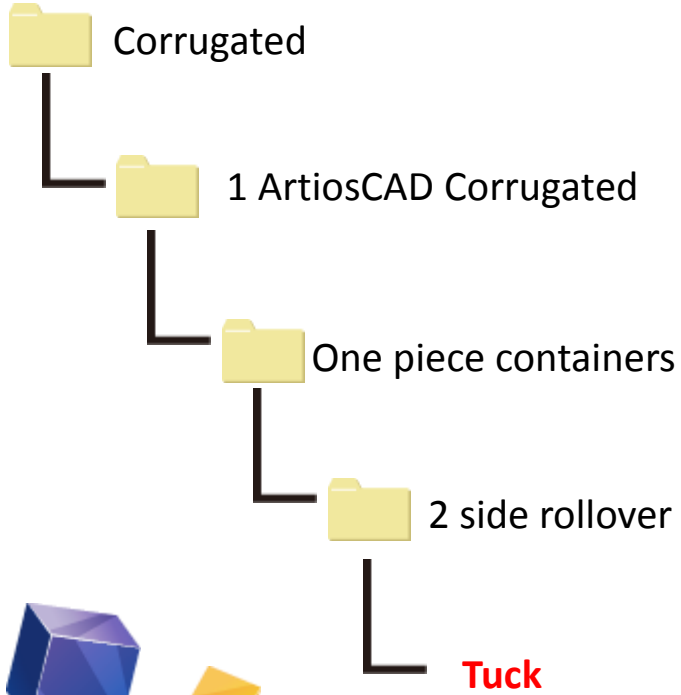

# 3 side rolover

ACDS.1-10

Mimaki™

File name

## Angled side/header slots

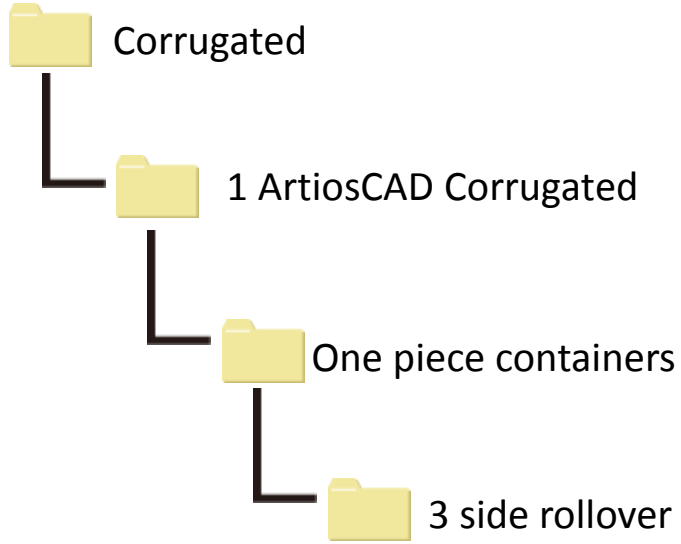

**Angled side/header slots**

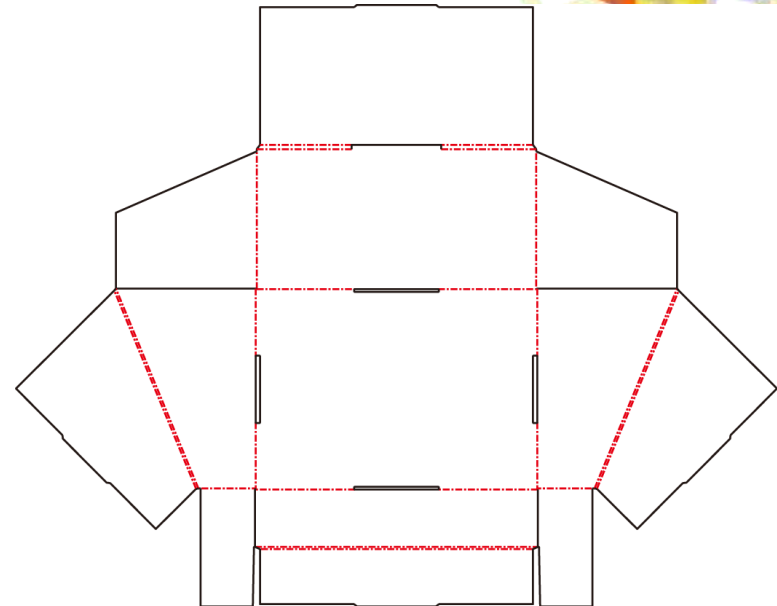

# 3 side rollover

ACDS.1-1

File name

## Cover flaps

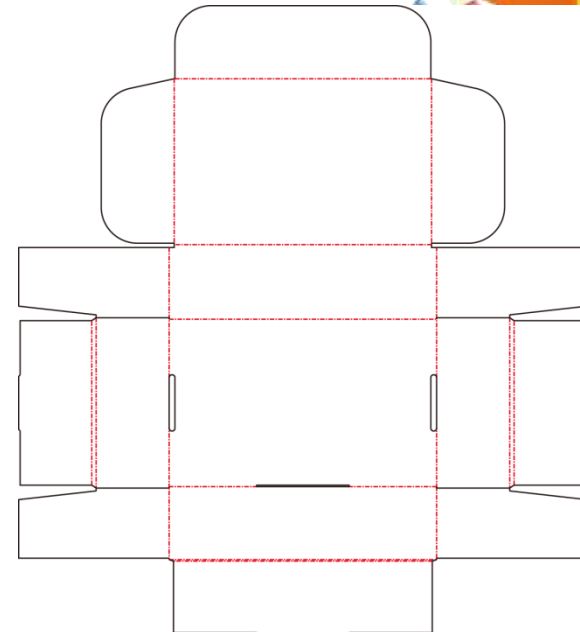
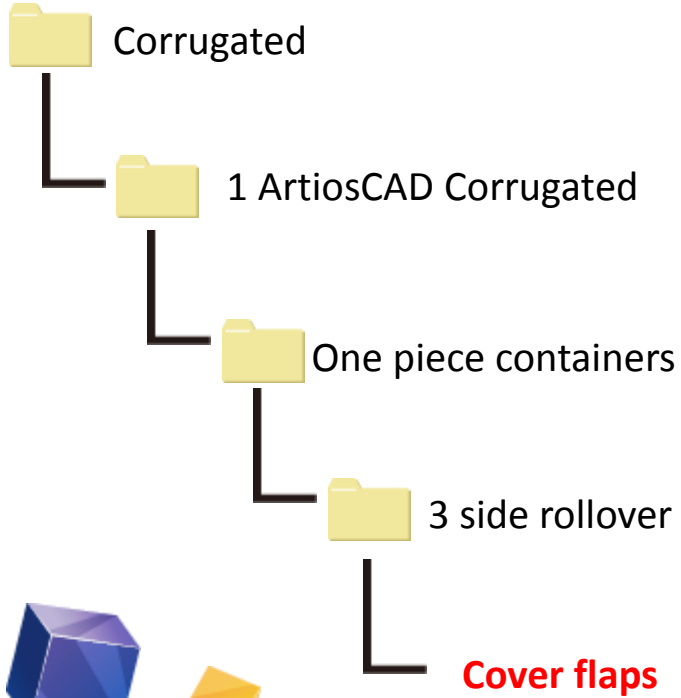

# 3 side rolover

ACDS.1-12

File name

# Tuck

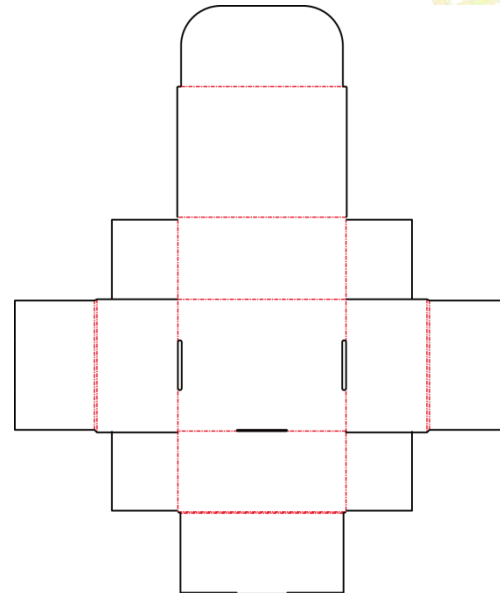
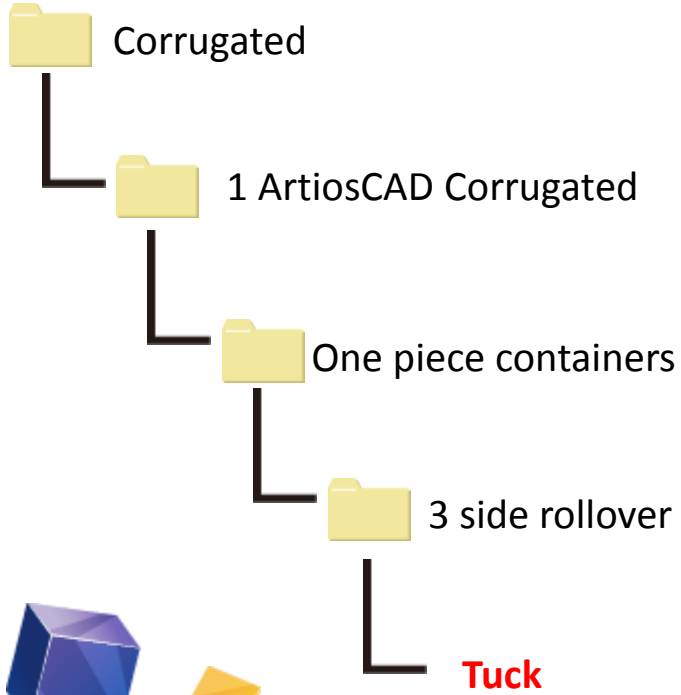

# Center joint

ACDS.1-13

File name

## With dust & cover flaps

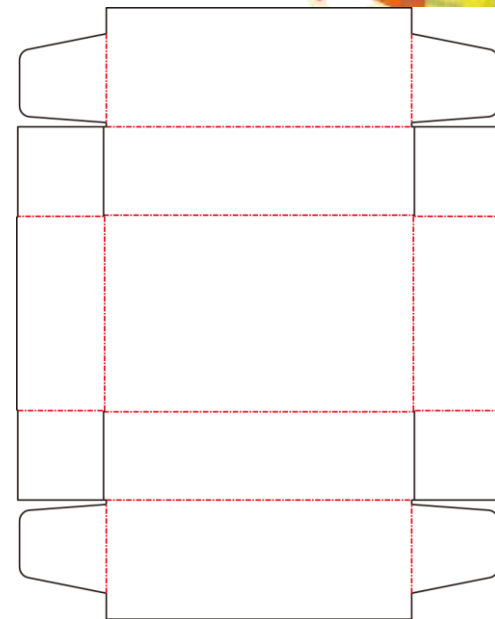
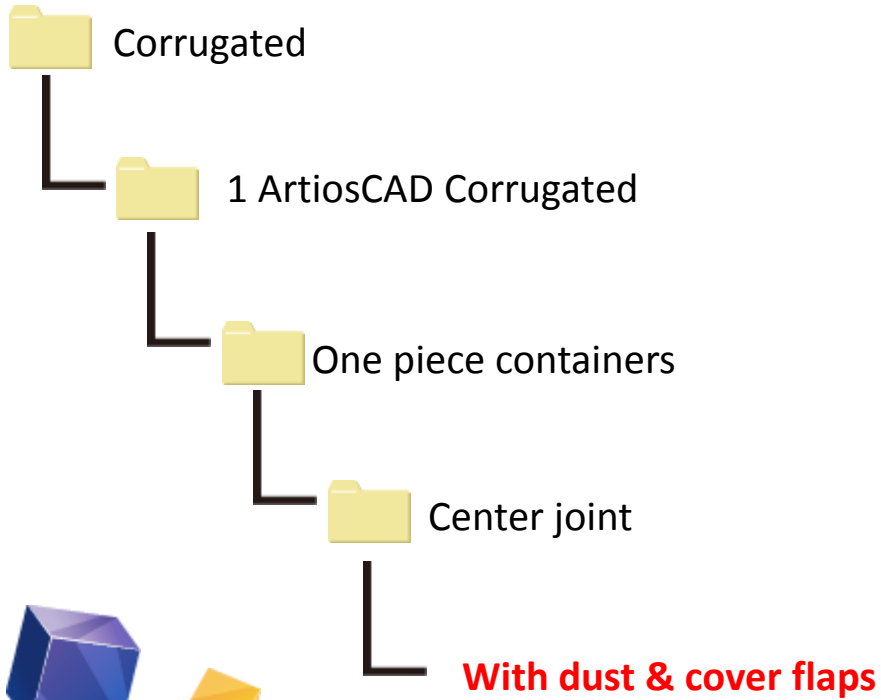

Mimaki™

# Center joint

ACDS.1-14

File name

## With dust flaps

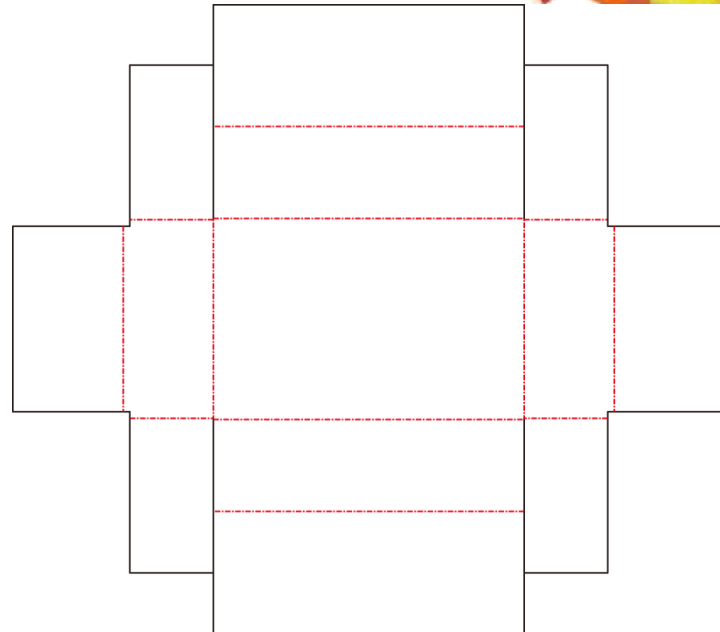
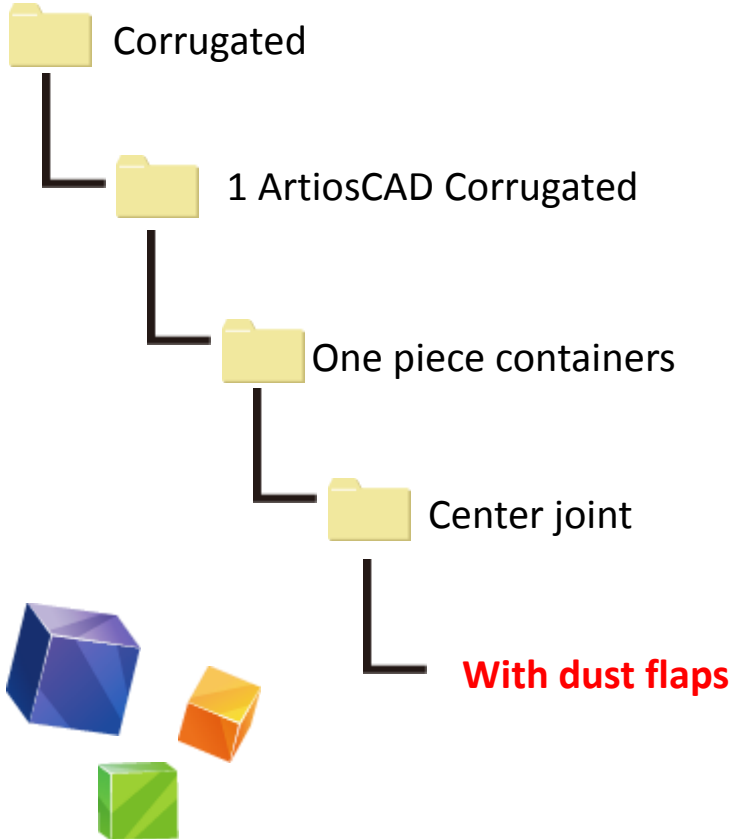

MIMAKI™



# Swing-in rolover

ACDS.1-15



File name

# 34011

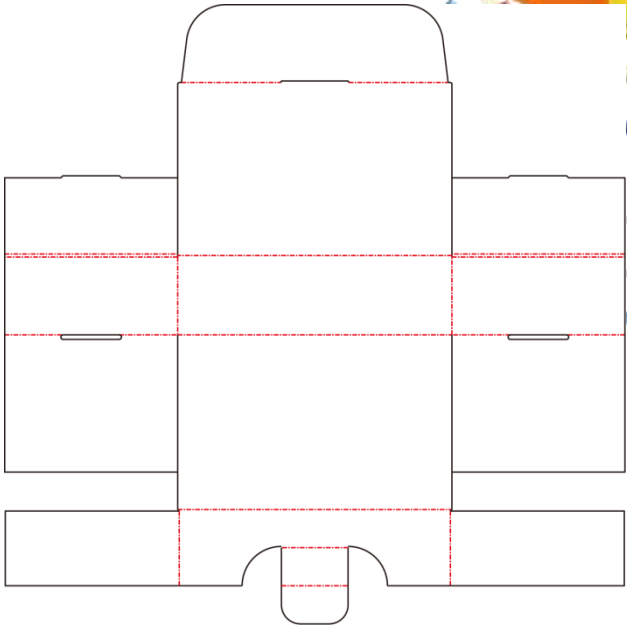
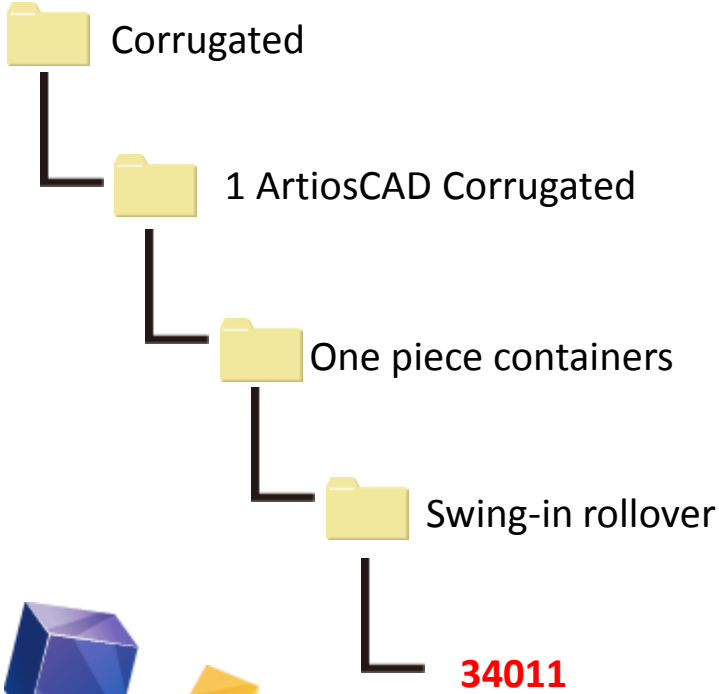

# Swing-in rolover

ACDS.1-16



File name

# 34020

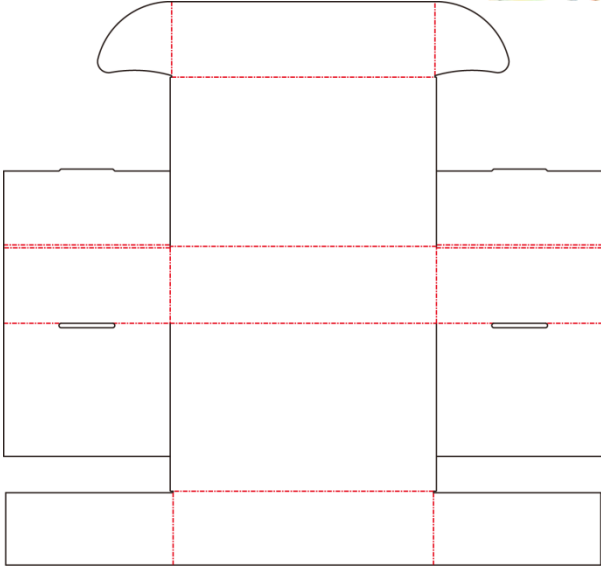
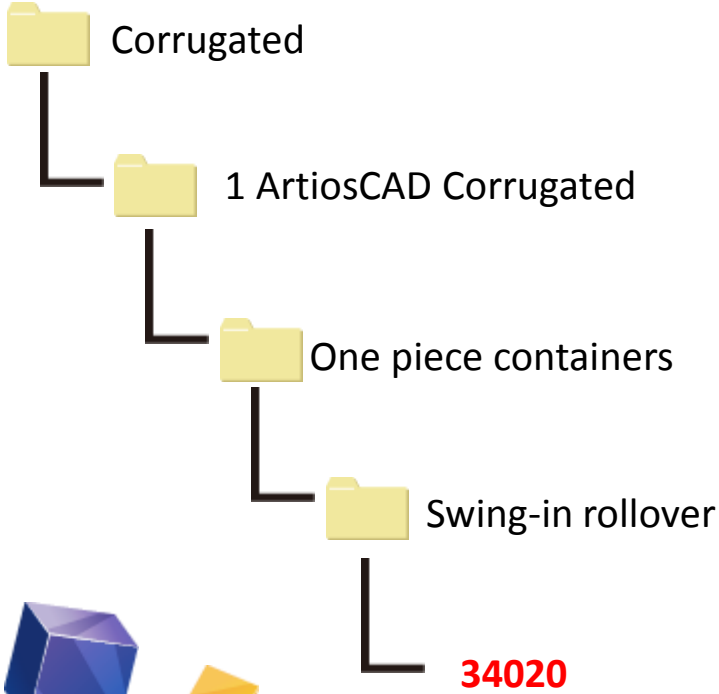

# Swing-in rolover

ACDS.1-17

Mimaki™

File name  
File name

Tuck

Corrugated

1 ArtiosCAD Corrugated

One piece containers

Swing-in rolover

Tuck

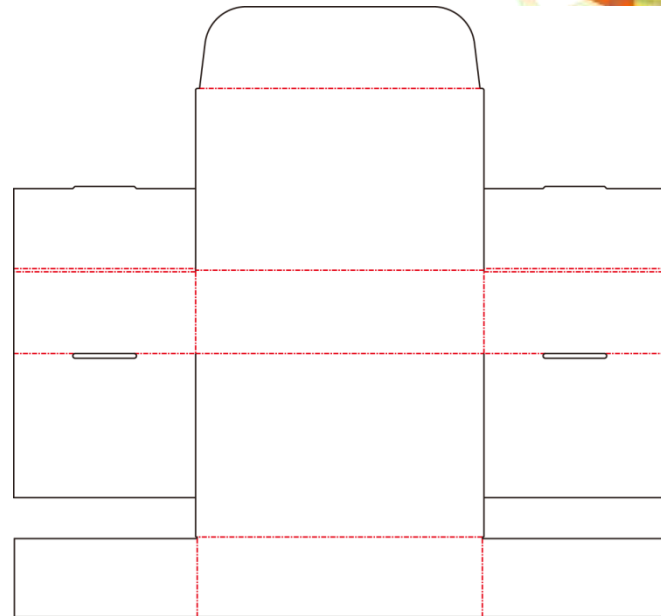

# Wrap around

ACDS.1-18

File name

## Tuck with optional lock

Corrugated

1 ArtiosCAD Corrugated

One piece containers

Swing-in rollover

**Tuck with optional lock**

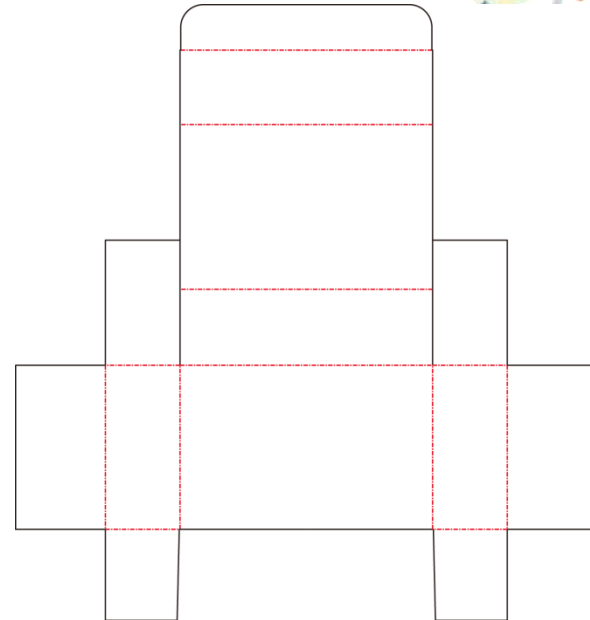

# Wrap around

ACDS.1-19

File name

**Tuck/cover flaps/opt, lock**

Corrugated

1 ArtiosCAD Corrugated

One piece containers

Swing-in rollover

**Tuck/cover flaps/opt, lock**

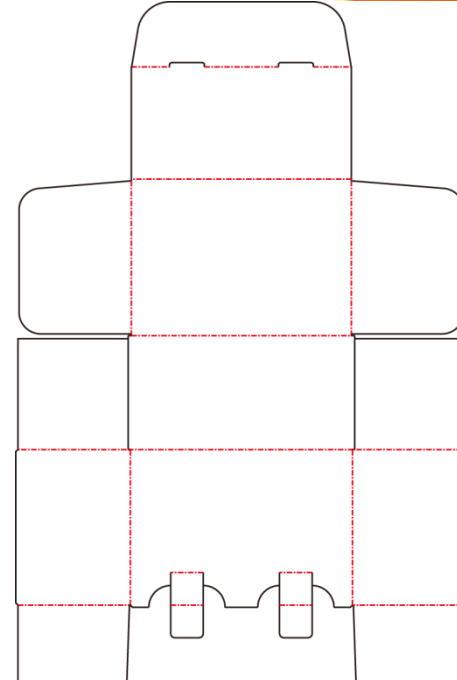

**Mimaki™**

# Trays

ACDS.1-20

Mimaki™

File name

## Angle side/with header slots

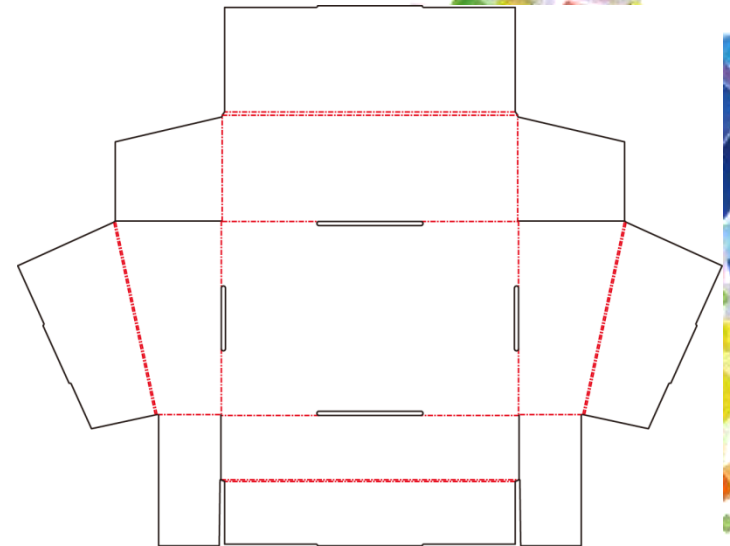
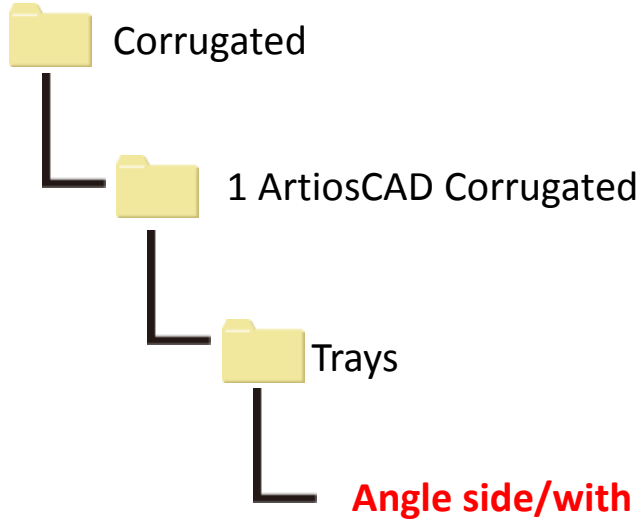

# Trays

ACDS.1-21

File name

## Four side rolover

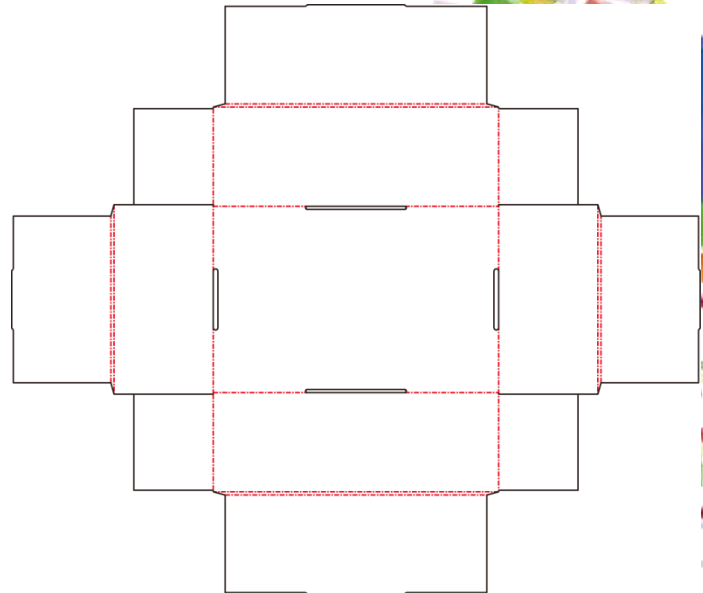
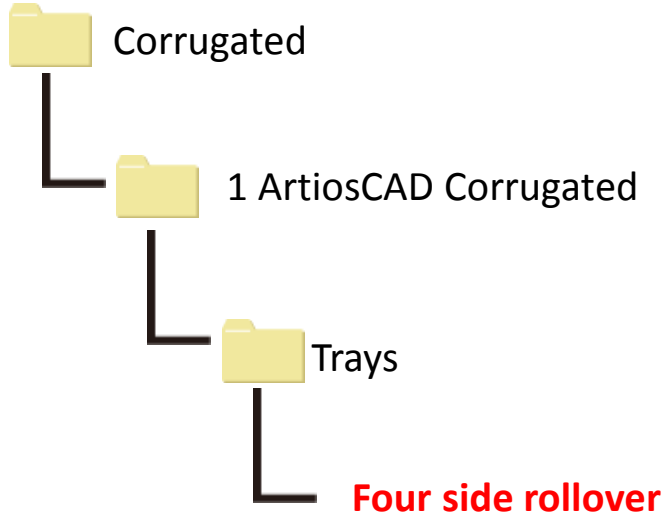

Mimaki™

# Trays

ACDS.1-22

File name

## Preglued infold

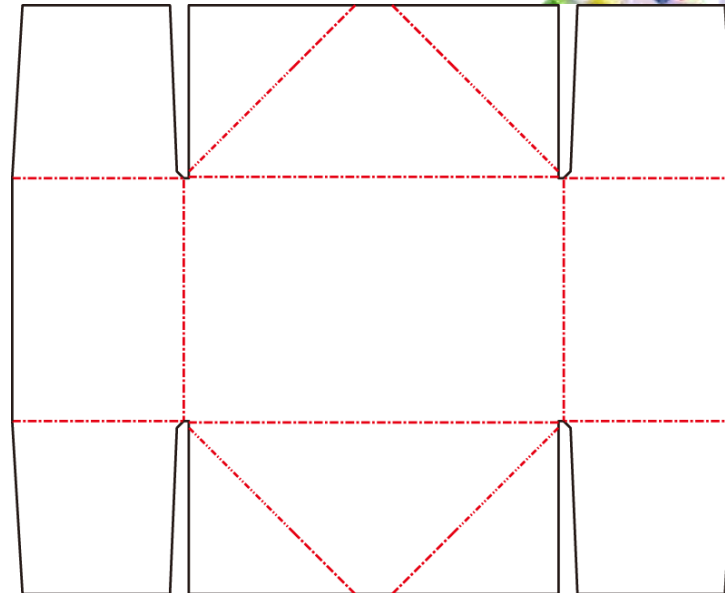
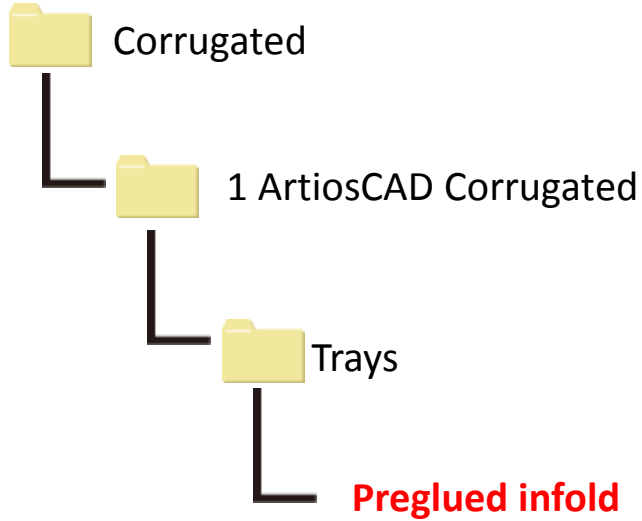



# Trays

ACDS.1-23

File name

## Preglued outfold

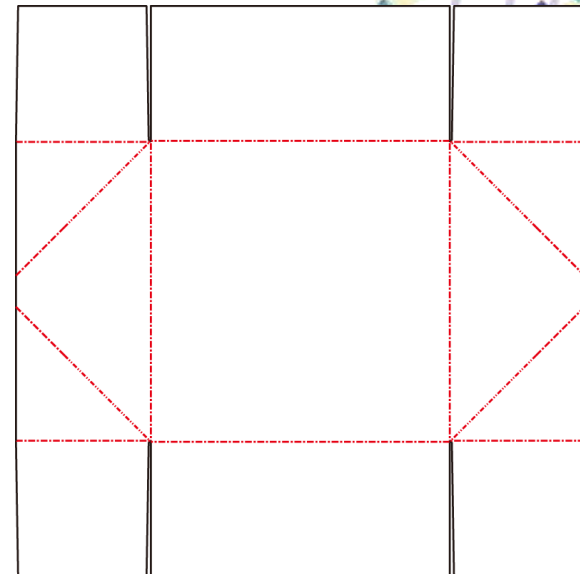
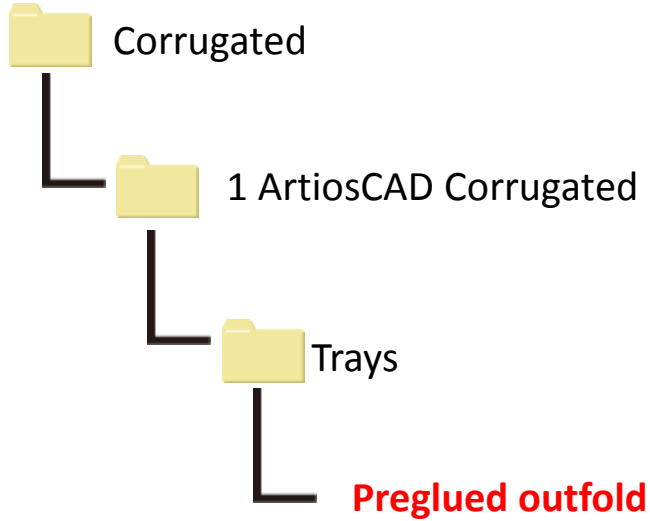

Mimaki™

# Trays

ACDS.1-24

File name

## Two side rollover

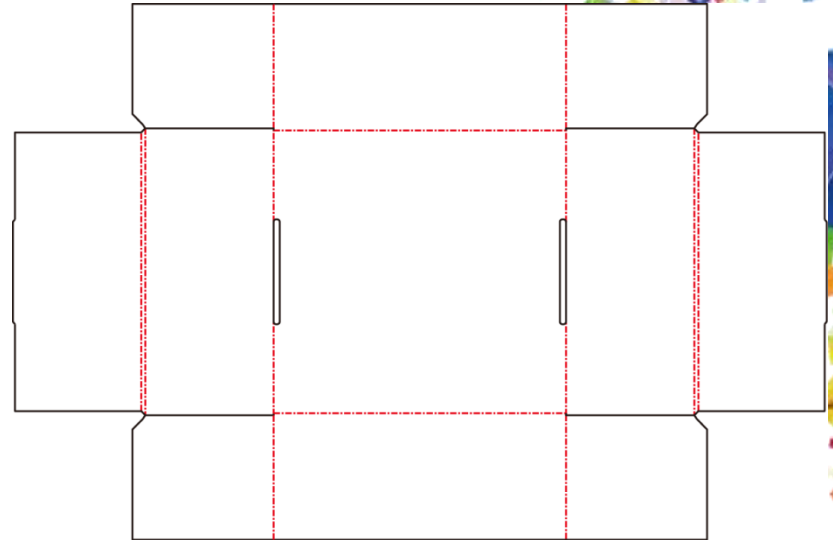
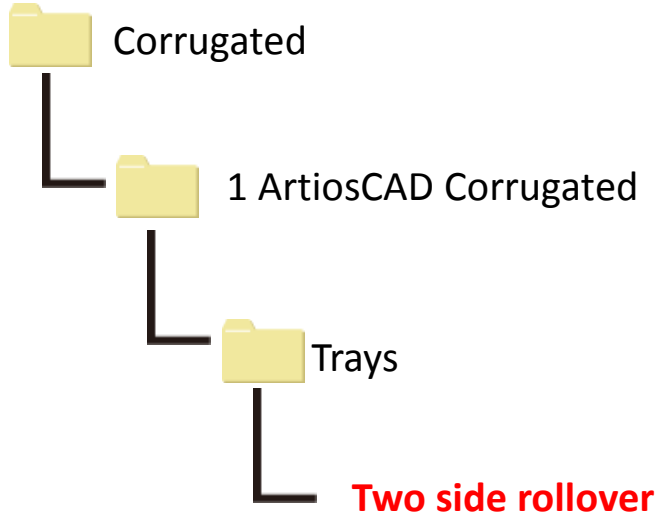

MIMAKI™